

RIDGE, HIP, PEAK, AND ROOF TRANSITION FLASHINGS

ROOF FLASHINGS WILL BE 4/12 PITCH UNLESS OTHERWISE SPECIFIED

RIDGE/HIP
RR12

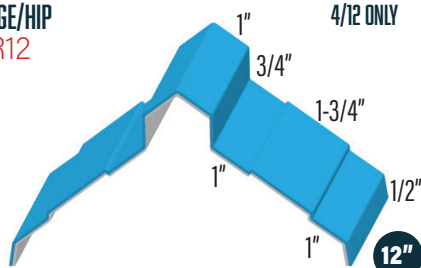

RIDGE/HIP
RR12H

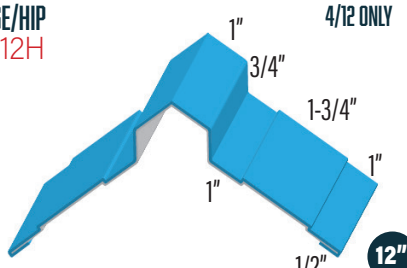

RIDGE/HIP
RC15

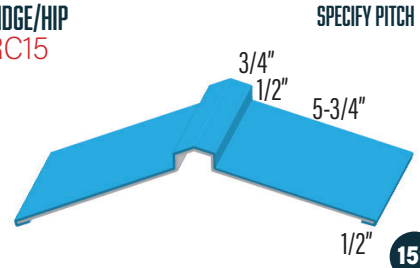

RIDGE/HIP
RC18

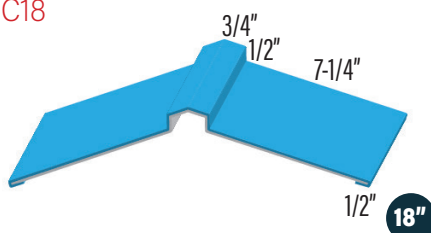

RIDGE/HIP
RC24

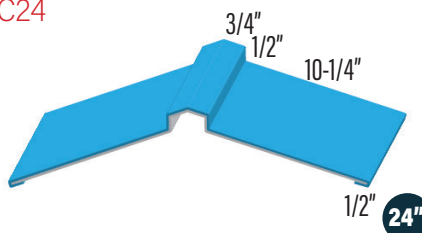

RIDGE/HIP
PROTEK

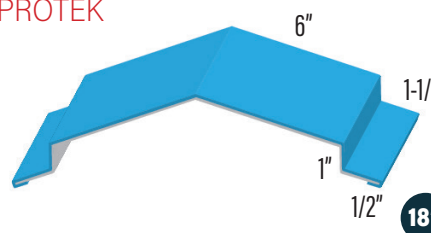

RIDGE/HIP
PRO12

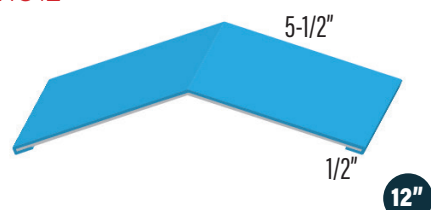

RIDGE/HIP
PRO15

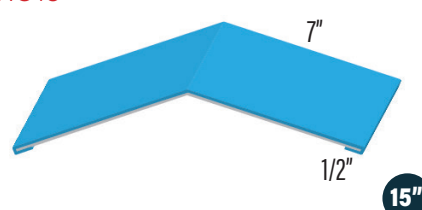

RIDGE/HIP
PRO18

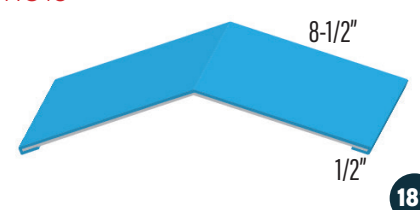

PEAK/SINGLE SLOPE

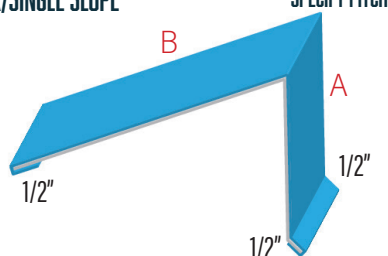

PROFILE	WEATHERSHIELD	DURACLAD/ALLCLAD DIAMOND	WF-7/8" CORRUGATED	PROLOK	WF-12-36	WF-636
---------	---------------	-----------------------------	-----------------------	--------	----------	--------

PEAK(CODE)	WSPEAK	DCPEAK	CORPEAK	PROPEAK	1236PEAK	636PEAK
A	3-3/4"	3-3/4"	4-1/4"	3-3/4"	5-1/4"	6-1/2"
B	6-3/4"	6-3/4"	6-1/4"	6-3/4"	8-1/4"	7"

MATERIAL	12"	12"	12"	12"	15"	15"
----------	-----	-----	-----	-----	-----	-----

ROOF TRANSITION
RT1

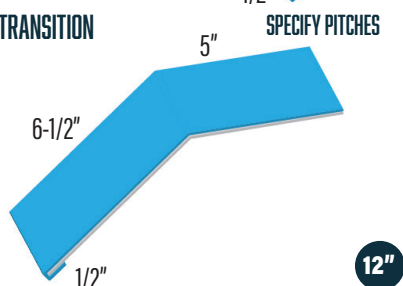

ROOF TRANSITION
RT2

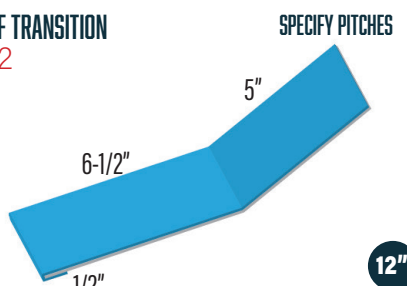

ROOF TRANSITION
RT2L

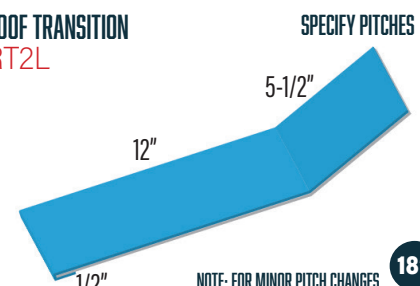

NOTE: FOR MINOR PITCH CHANGES

WIDTH	GALV / LUME 29 GAUGE	SMP 29 GAUGE	GALV / LUME 26 GAUGE	SMP 26 GAUGE	PVDF/TEX 26 GAUGE	GALV / LUME 24 GAUGE	SMP 24 GAUGE	PVDF/TEX 24 GAUGE	ALUMINUM 24 GAUGE
4"									
6"									
9"									
12"									
15"									
18"									
24"									
30"									
36"									

EAVE AND SNOW STOP FLASHINGS

ROOF FLASHINGS WILL BE 4/12 PITCH UNLESS OTHERWISE SPECIFIED

EAVE (STANDARD)

SPECIFY PITCH

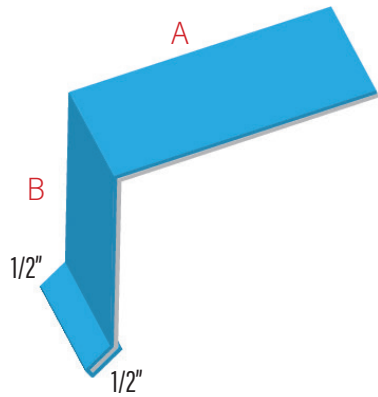

PROFILE	WEATHERSHIELD	DURACLAD/ALLCLAD DIAMOND	WF-7/8" CORRUGATED	PROLOK	WF-12-36	WF-636
EAVE(CODE)	WSEAVE	DCEAVE	COREAVE	PROEAVE	1236EAVE	636EAVE
A	3-3/4"	4"	4"	4"	4"	3-1/4"
B	3-1/4"	2-3/4"	3-1/8"	2-1/2"	3-7/8"	4-3/4"
MATERIAL	9"	9"	9"	9"	9"	9"

HOOK EAVE EAVEH

SPECIFY PITCH

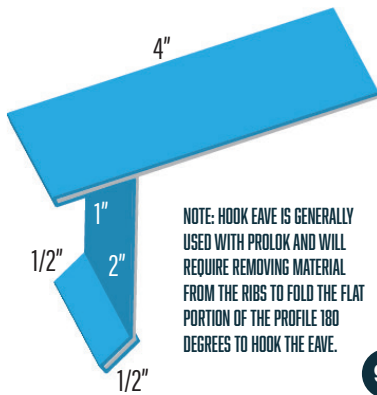

NOTE: HOOK EAVE IS GENERALLY USED WITH PROLOK AND WILL REQUIRE REMOVING MATERIAL FROM THE RIBS TO FOLD THE FLAT PORTION OF THE PROFILE 180 DEGREES TO HOOK THE EAVE.

9"

EAVE EAVES

SPECIFY PITCH

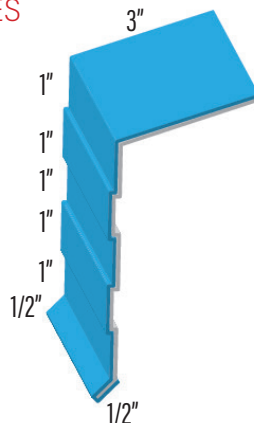

26 GAUGE OR HEAVIER
DURACLAD
ALLCLAD
DIAMOND
WF-12-36
WF-636R
WF-7/8" CORRUGATED

9"

EAVE EAVESV

SPECIFY PITCH

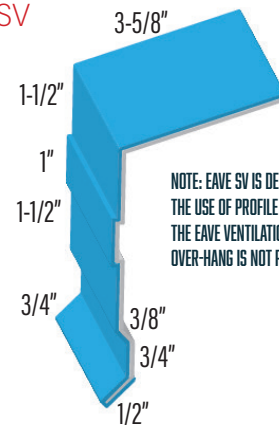

NOTE: EAVE SV IS DESIGNED WITH THE USE OF PROFILE VENT FOR THE EAVE VENTILATION WHEN AN OVER-HANG IS NOT PRESENT.

12"

SNOW STOP SS1

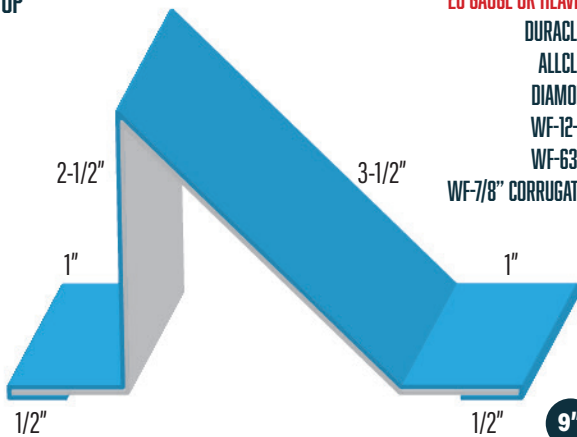

9"

SNOW STOP SS2

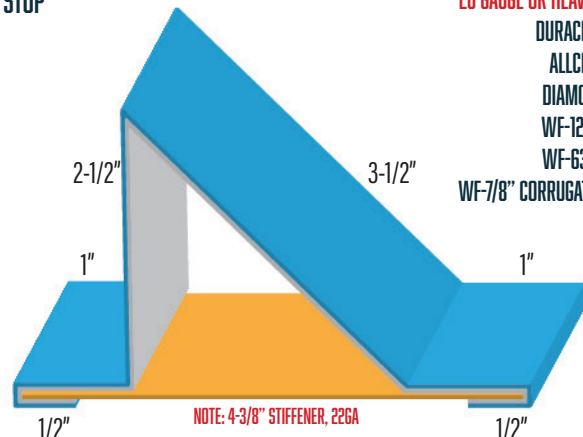

NOTE: 4-3/8" STIFFENER, 22GA

26 GAUGE OR HEAVIER
DURACLAD
ALLCLAD
DIAMOND
WF-12-36
WF-636R
WF-7/8" CORRUGATED

WIDTH	GALV / LUME 29 GAUGE	SMP 29 GAUGE	GALV / LUME 26 GAUGE	SMP 26 GAUGE	PVDF/TEX 26 GAUGE	GALV / LUME 24 GAUGE	SMP 24 GAUGE	PVDF/TEX 24 GAUGE	ALUMINUM 24 GAUGE
4"									
6"									
9"									
12"									
15"									
18"									
24"									
30"									
SS2									

GABLE FLASHINGS

WEATHERSHIELD
WSGT

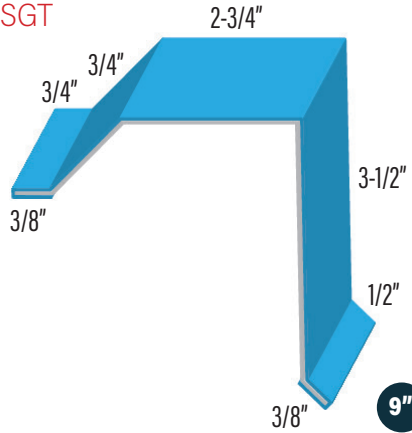

DURACLAD/ALLCLAD/DIAMOND
DCGT

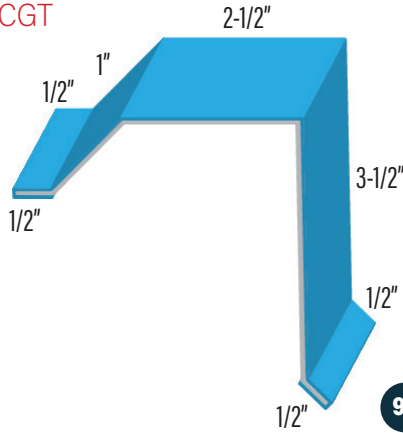

WF-7/8" CORRUGATED
CORGT

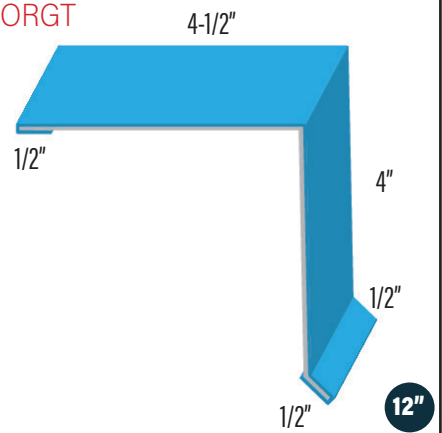

PROLOK
PRGT

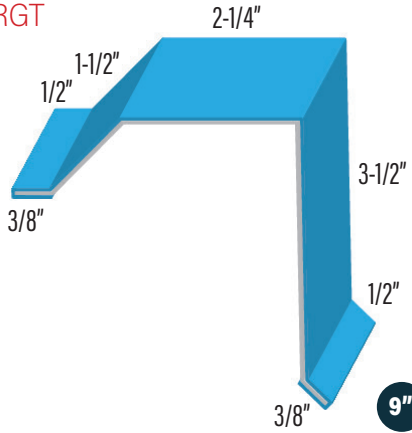

WF-12-36
1236GT

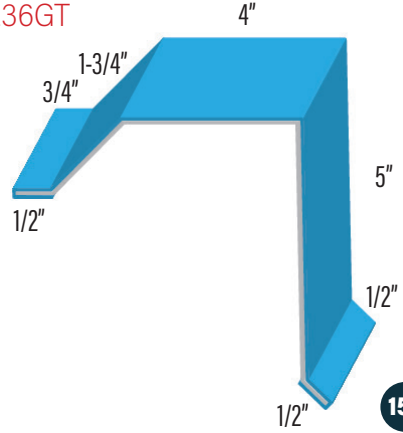

WF-636
636GT

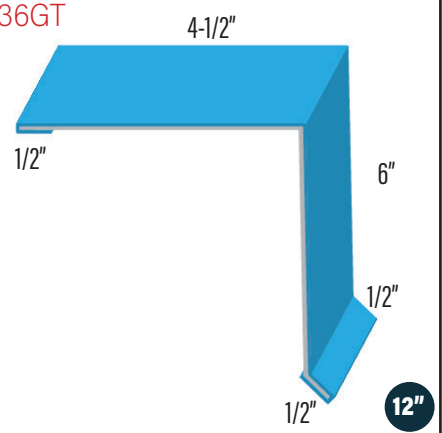

GTS
GTS

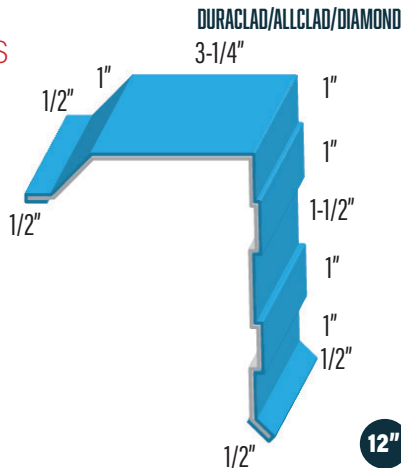

WIDTH	GALV / LUME 29 GAUGE	SMP 29 GAUGE	GALV / LUME 26 GAUGE	SMP 26 GAUGE	PVDF/TEX 26 GAUGE	GALV / LUME 24 GAUGE	SMP 24 GAUGE	PVDF/TEX 24 GAUGE	ALUMINUM 24 GAUGE
4"									
6"									
9"									
12"									
15"									
18"									
24"									
30"									
36"									

TERMS NET 30 DAYS. PRICES SUBJECT TO CHANGE WITHOUT NOTICE.

PROW GABLE FLASHINGS

PROW GABLES ARE FOR GABLE ENDS GREATER THAN 90° TO THE EAVE

WEATHERSHIELD
WSPROW

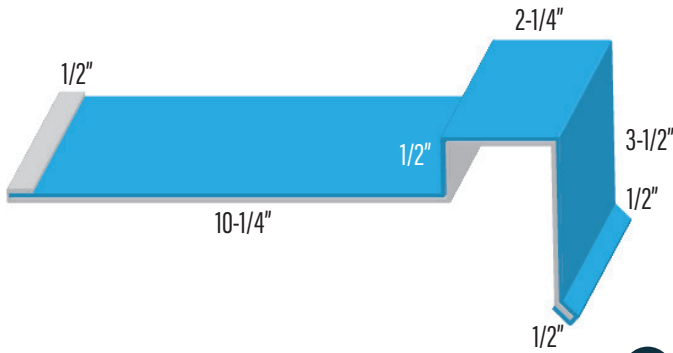

18"

DURACLAD/ALLCLAD/DIAMOND
DCPROW

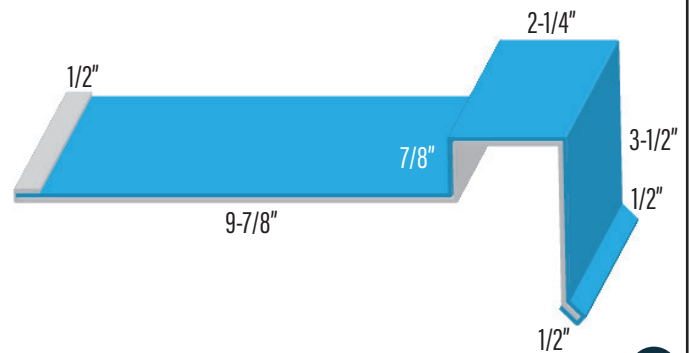

18"

WF-7/8" CORRUGATED
CORPROW

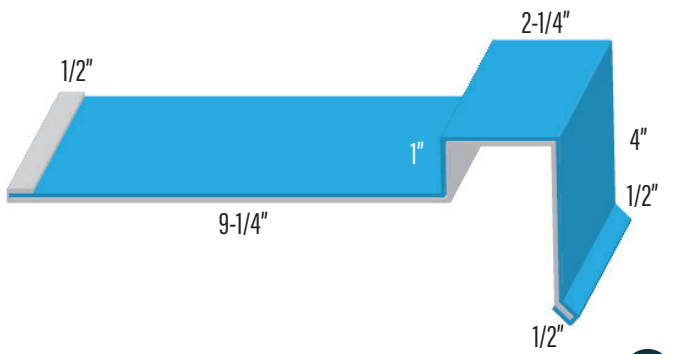

18"

PROLOK
PRPROW

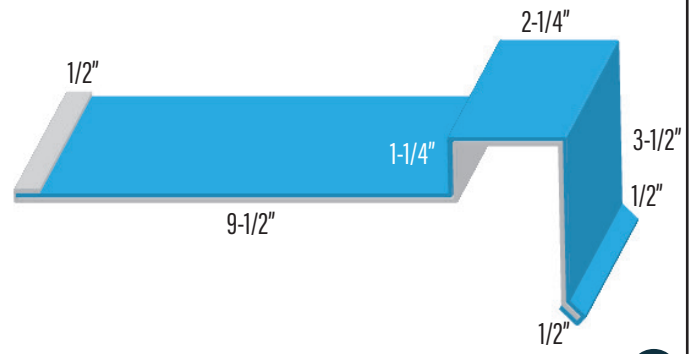

18"

WF-12-36
1236PROW

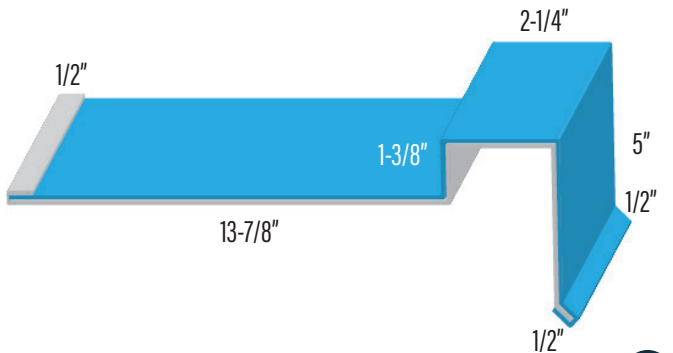

24"

WF-636
636PROW

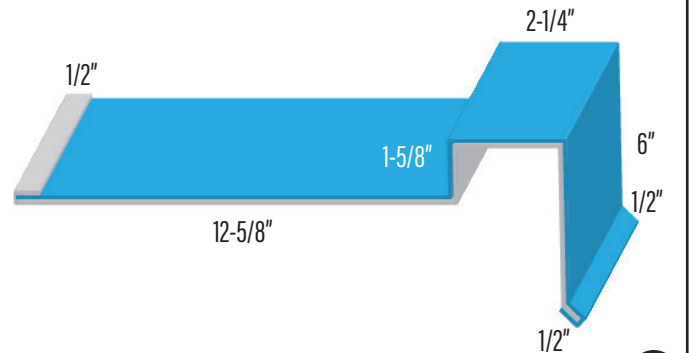

24"

WIDTH	GALV / LUME 29 GAUGE	SMP 29 GAUGE	GALV / LUME 26 GAUGE	SMP 26 GAUGE	PVDF/TEX 26 GAUGE	GALV / LUME 24 GAUGE	SMP 24 GAUGE	PVDF/TEX 24 GAUGE	ALUMINUM 24 GAUGE
4"									
6"									
9"									
12"									
15"									
18"									
24"									
30"									
36"									

TERMS NET 30 DAYS. PRICES SUBJECT TO CHANGE WITHOUT NOTICE.

VALLEY, END WALL, SIDE WALL FLASHINGS

ROOF FLASHINGS WILL BE 4/12 PITCH UNLESS OTHERWISE SPECIFIED

W VALLEY 24"
WV24

SPECIFY PITCH

W VALLEY 36"
WV36

SPECIFY PITCH

V VALLEY 36"
V36

SPECIFY PITCH

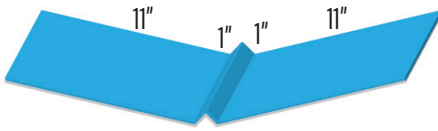

24"

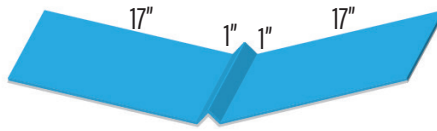

36"



36"

W VALLEY 36" HOOK
WVH36

SPECIFY PITCH

V VALLEY 36" HOOK
VH36

SPECIFY PITCH

END WALL
EW

SPECIFY PITCH

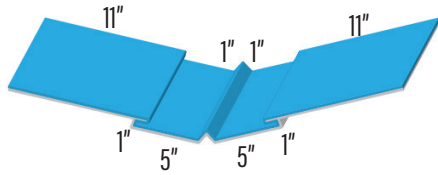

36"

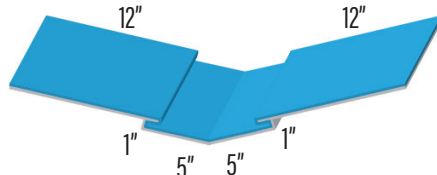

36"

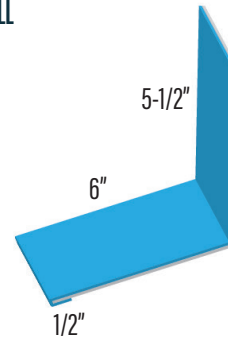

12"

SIDE WALL WEATHERSHIELD
WSSW

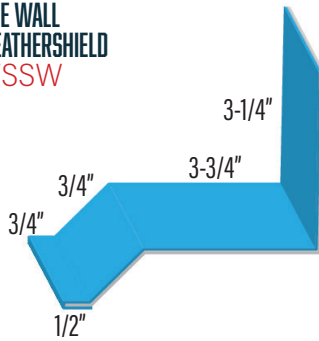

9"

SIDE WALL DURACLAD/ALLCLAD/DIAMOND
DCSW

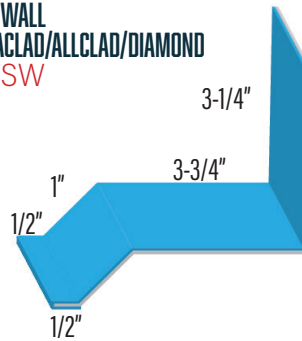

9"

SIDE WALL WF-7/8" CORRUGATED
CORSW

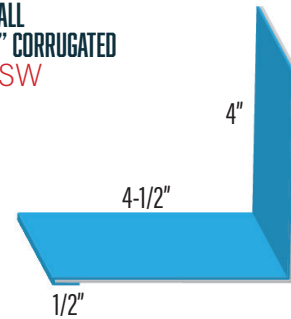

9"

SIDE WALL PROLOK
PRSW

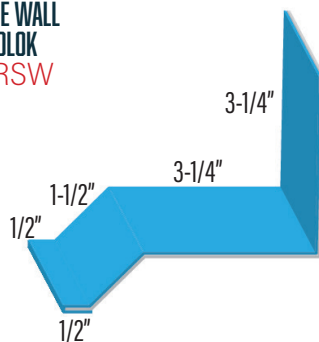

9"

SIDE WALL WF-12-36
1236SW

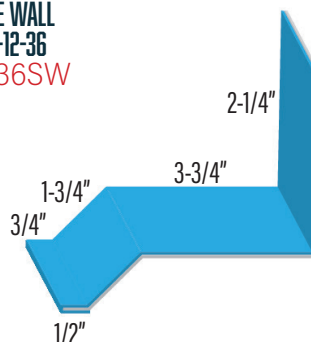

9"

SIDE WALL WF-636
636SW

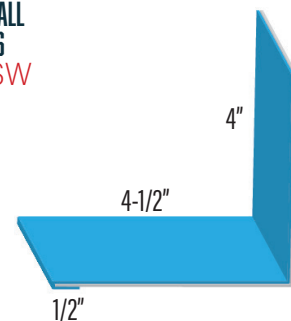

9"

WIDTH	GALV / LUME 29 GAUGE	SMP 29 GAUGE	GALV / LUME 26 GAUGE	SMP 26 GAUGE	PVDF/TEX 26 GAUGE	GALV / LUME 24 GAUGE	SMP 24 GAUGE	PVDF/TEX 24 GAUGE	ALUMINUM 24 GAUGE
4"									
6"									
9"									
12"									
15"									
18"									
24"									
30"									
36"									

TERMS NET 30 DAYS. PRICES SUBJECT TO CHANGE WITHOUT NOTICE.

FASCIA FLASHINGS

FC 6, 8, 10
FC(6,8,10)

FC **A** TOTAL MATERIAL

6 5-1/2 9"

8 7-1/2 12"

10 9-1/2 15"

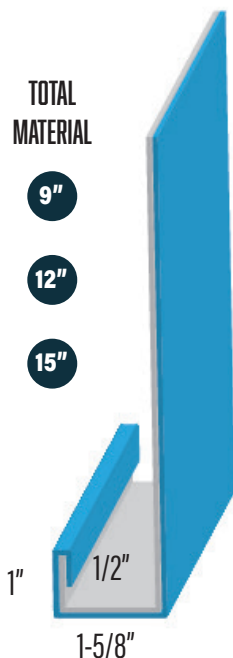

FR 6, 8, 10
FR(6,8,10)

FR **A** TOTAL MATERIAL

6 5-1/2 9"

8 7-1/2 12"

10 9-1/2 15"

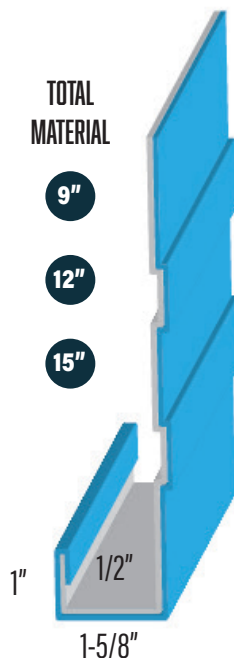

RIBS EVENLY SPACED

LT 6, 8, 10
LT(6,8,10)

LT **A** TOTAL MATERIAL

6 5-1/2 9"

8 7-1/2 9"

10 9-1/2 12"

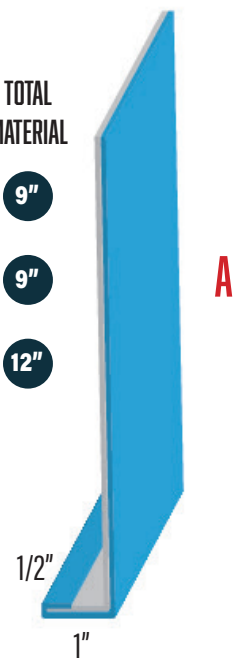

LTR 6, 8, 10
LTR(6,8,10)

LTR **A** TOTAL MATERIAL

6 5-1/2 9"

8 7-1/2 12"

10 9-1/2 12"

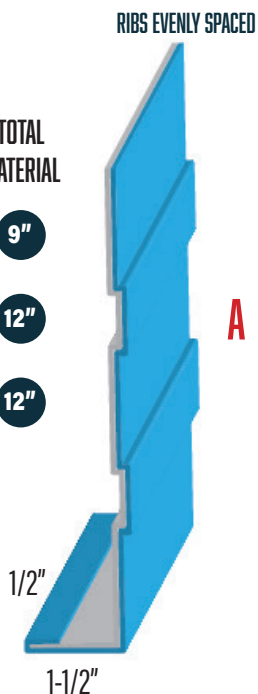

FLUSH FASCIA
PROBOARD
PBFF

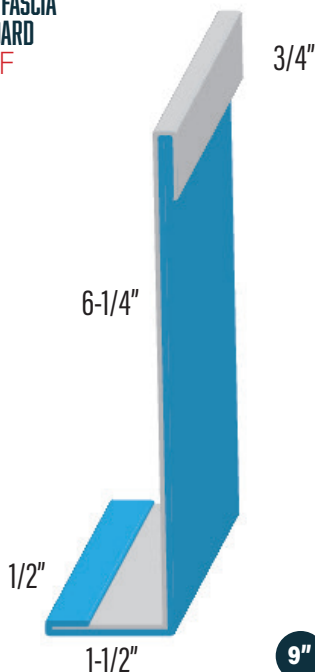

DROP FASCIA
PROBOARD
PDBF

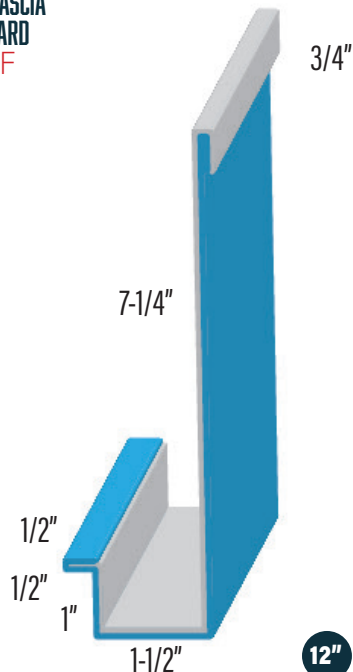

WIDTH	GALV / LUME 29 GAUGE	SMP 29 GAUGE	GALV / LUME 26 GAUGE	SMP 26 GAUGE	PVDF/TEX 26 GAUGE	GALV / LUME 24 GAUGE	SMP 24 GAUGE	PVDF/TEX 24 GAUGE	ALUMINUM 24 GAUGE
4"									
6"									
9"									
12"									
15"									
18"									
24"									
30"									
36"									

DOOR MOLDING FLASHINGS

DOOR MOLDING DRIP
DMD1

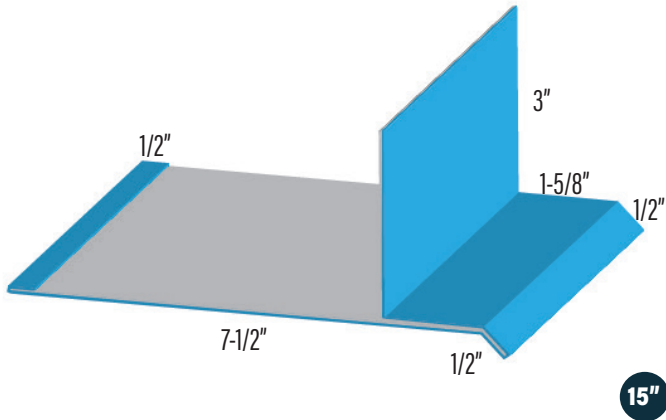

DOOR MOLDING DRIP
DMD2

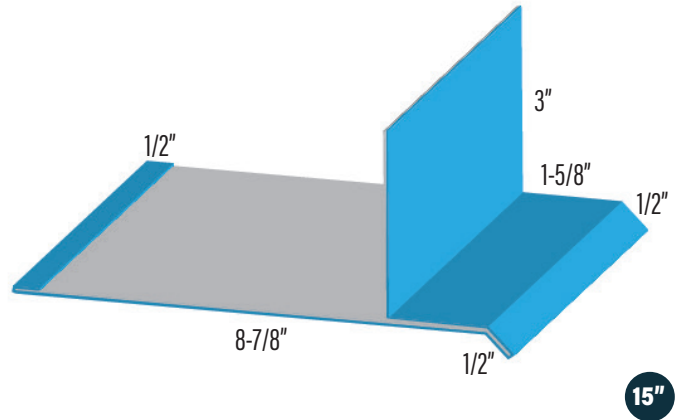

DOOR MOLDING EDGE
DM1

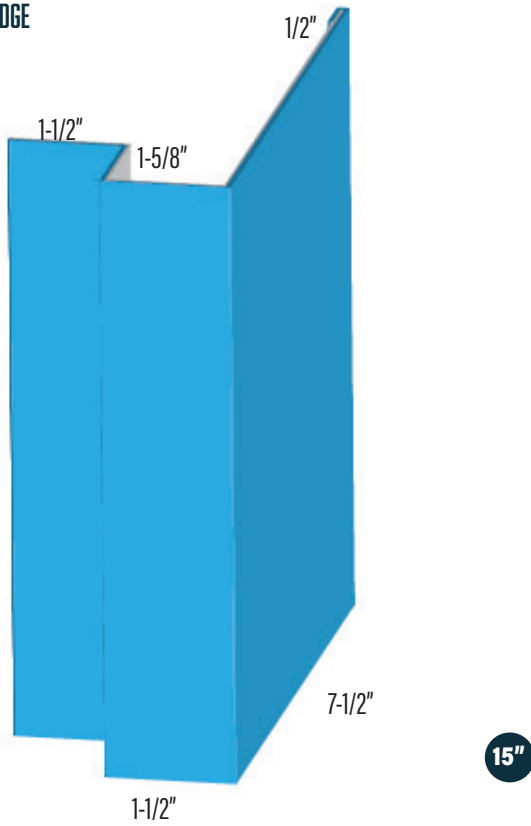

DOOR MOLDING EDGE
DM2

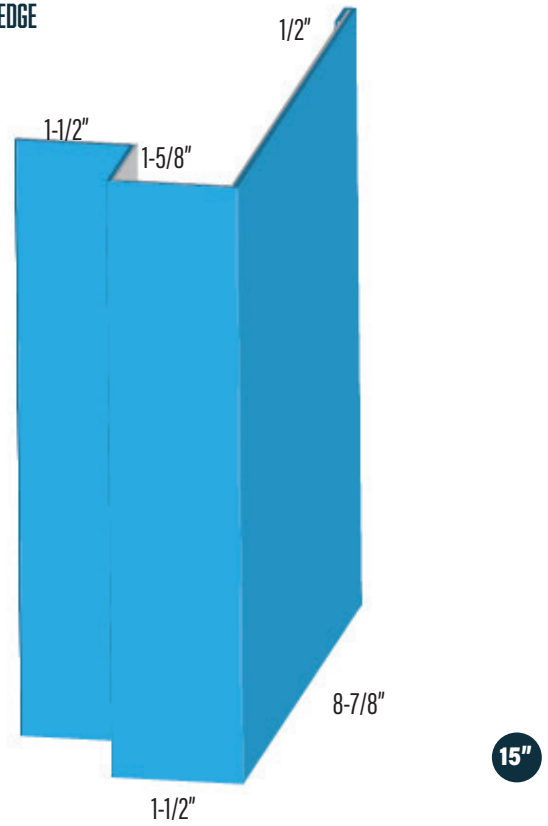

WIDTH	GALV / LUME 29 GAUGE	SMP 29 GAUGE	GALV / LUME 26 GAUGE	SMP 26 GAUGE	PVDF/TEX 26 GAUGE	GALV / LUME 24 GAUGE	SMP 24 GAUGE	PVDF/TEX 24 GAUGE	ALUMINUM 24 GAUGE
4"									
6"									
9"									
12"									
15"									
18"									
24"									
30"									
36"									

TERMS NET 30 DAYS. PRICES SUBJECT TO CHANGE WITHOUT NOTICE.

OVER HEAD DOORS AND CANNONBALL COVER FLASHINGS

OVER HEAD DOOR DRIP
OHDD

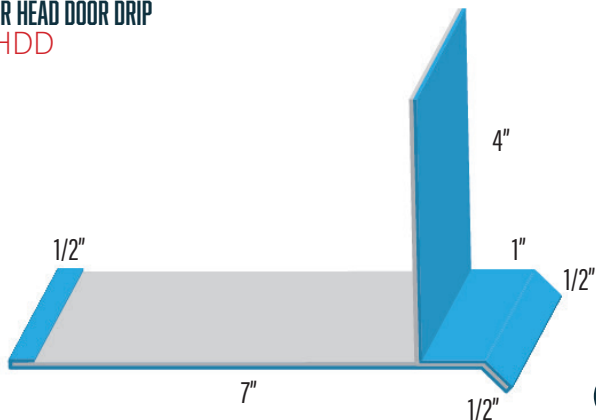

15"

OVER HEAD DOOR DRIP
PBJHD

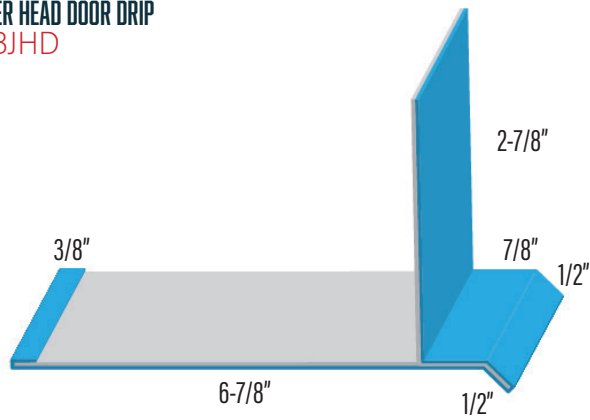

12"

OVER HEAD DOOR EDGE
OHDE

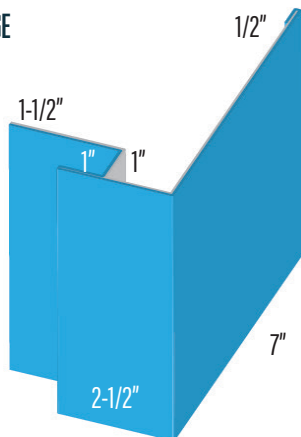

15"

OVER HEAD DOOR EDGE
PBJED

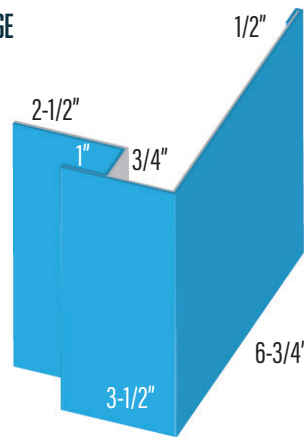

15"

CANNONBALL TRACK COVER
FACE KWIK-FRAME SINGLE TRACK



12"

CANNONBALL TRACK COVER
FACE BIGG-BIGG SINGLE TRACK



12"

CANNONBALL TRACK COVER
FACE DOUBLE TRACK

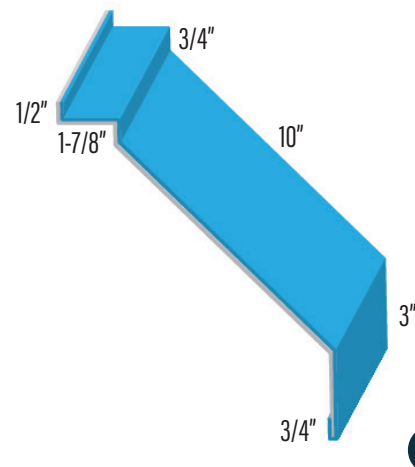

18"

WIDTH	GALV / LUME 29 GAUGE	SMP 29 GAUGE	GALV / LUME 26 GAUGE	SMP 26 GAUGE	PVDF/TEX 26 GAUGE	GALV / LUME 24 GAUGE	SMP 24 GAUGE	PVDF/TEX 24 GAUGE	ALUMINUM 24 GAUGE
4"									
6"									
9"									
12"									
15"									
18"									
24"									
30"									
36"									

WALL BASE AND HEADER FLASHINGS

WALL BASE AND HEADER TRIMS WILL BE BENT WITH A 5° SLOPE

WALL BASE - COLOR 1 SIDE
MESA
WMDC

5° SLOPE

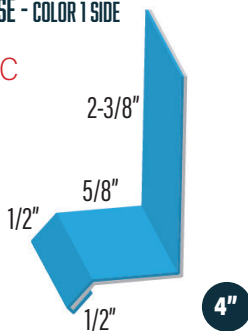

WALL BASE - COLOR 1 SIDE
WEATHERSHIELD
WSDC

5° SLOPE

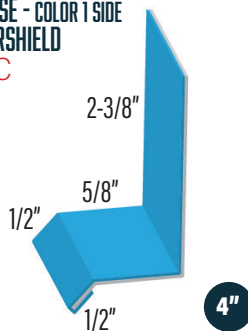

WALL BASE - COLOR 1 SIDE
PROBOARD
PBDC

5° SLOPE

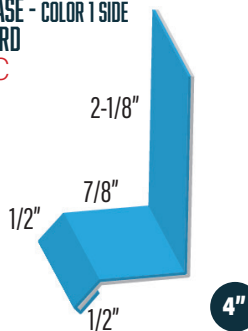

WALL BASE - COLOR 1 SIDE
DURACLAD/ALLCLAD/
DIAMOND
DCDC

5° SLOPE

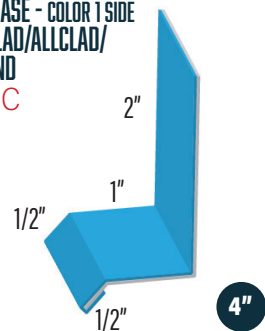

WALL BASE - COLOR 1 SIDE
WF-7/8" CORRUGATED
CORDC

5° SLOPE

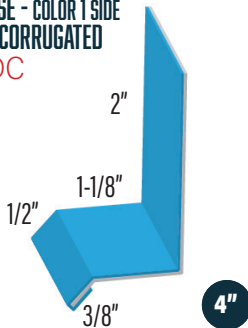

WALL BASE - COLOR 1 SIDE
WF-HF/PROLOK
HFDC

5° SLOPE

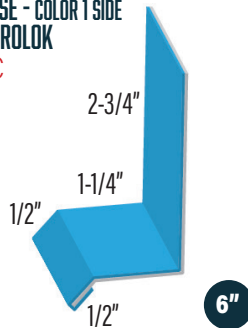

WALL BASE - COLOR 1 SIDE
WF-12-36
1236DC

5° SLOPE

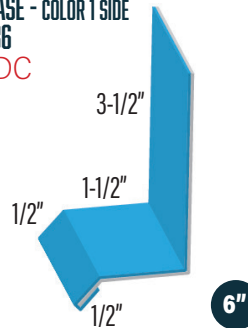

WALL BASE - COLOR 1 SIDE
WF-636
636DC

5° SLOPE

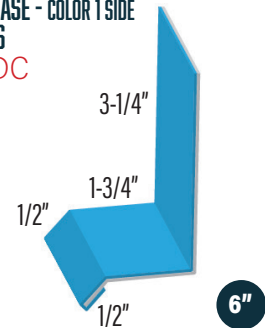

HEADER - COLOR 2 SIDE
WEATHERSHIELD
WSHD

5° SLOPE

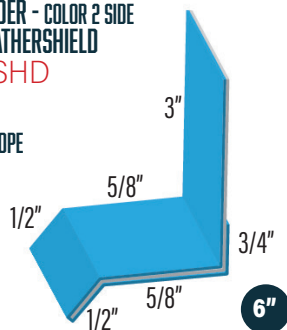

HEADER - COLOR 2 SIDE
PROBOARD
PBHD

5° SLOPE

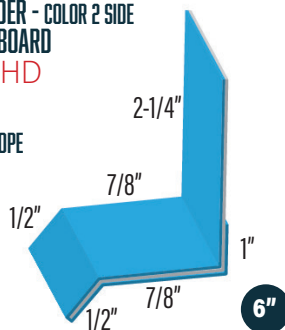

HEADER - COLOR 2 SIDE
DURACLAD/ALLCLAD/
DIAMOND
DCHD

5° SLOPE

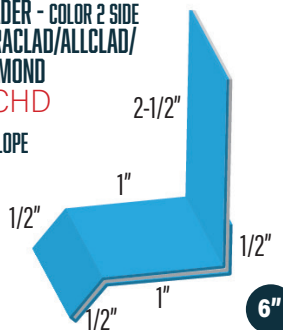

HEADER - COLOR 2 SIDE
WF-7/8" CORRUGATED
CORHD

5° SLOPE

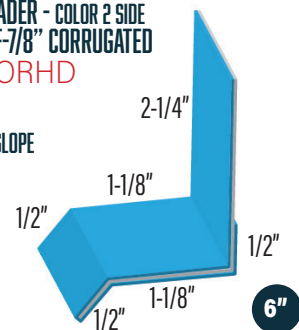

HEADER - COLOR 2 SIDE
WF-HF/PROLOK
HFHD

5° SLOPE

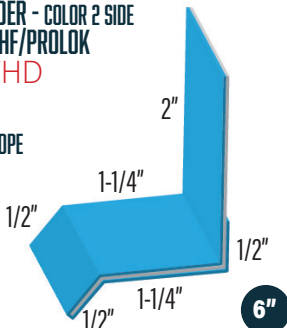

HEADER - COLOR 2 SIDE
WF-12-36
1236HD

5° SLOPE

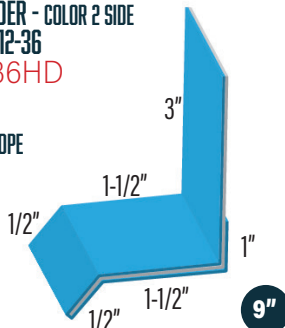

HEADER - COLOR 2 SIDE
WF-636
636HD

5° SLOPE

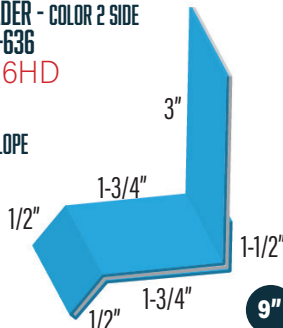

REVERSE WALL BASE AND HEADER
EX. (Profile)DCR
or (Profile)HDR

5° SLOPE

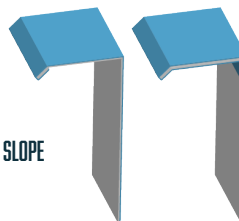

WIDTH	GALV / LUME 29 GAUGE	SMP 29 GAUGE	GALV / LUME 26 GAUGE	SMP 26 GAUGE	PVDF/TEX 26 GAUGE	GALV / LUME 24 GAUGE	SMP 24 GAUGE	PVDF/TEX 24 GAUGE	ALUMINUM 24 GAUGE
4"									
6"									
9"									
12"									
15"									
18"									
24"									
30"									
36"									

J TRIM FLASHINGS

JT2 J TRIMS WILL HAVE COLOR INSIDE AND OUT

J TRIM MESA
WMJM

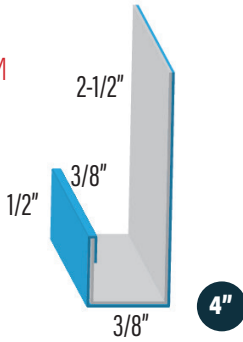

J TRIM 1 - COLOR 1 SIDE WEATHERSHIELD
WSJT1

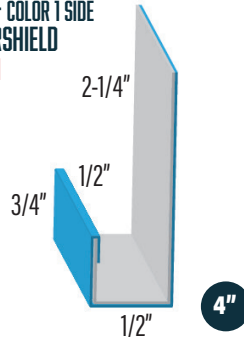

J TRIM PROBOARD
PBJT

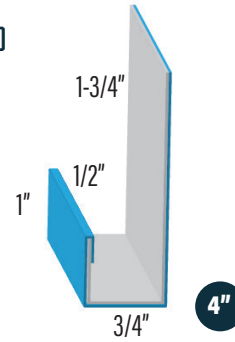

J TRIM 1 - COLOR 1 SIDE DURACLAD/ALLCLAD/DIAMOND
DCJT1

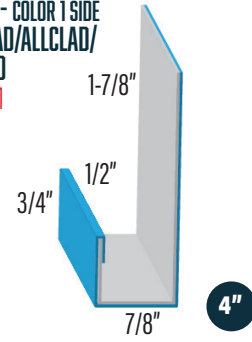

J TRIM 1 - COLOR 1 SIDE WF-7/8" CORRUGATED
CORJT1

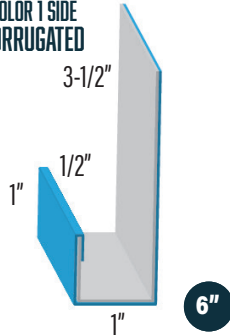

J TRIM 1 - COLOR 1 SIDE WF-HF
HFJT1

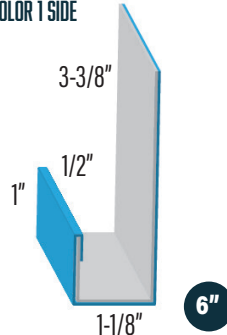

J TRIM 1 - COLOR 1 SIDE WF-12-36
1236JT1

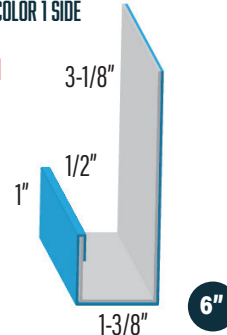

J TRIM 1 - COLOR 1 SIDE WF-636
636JT1

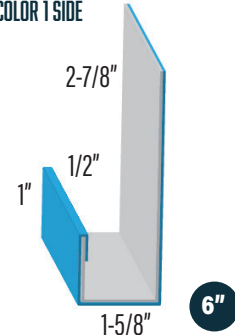

J TRIM 2 - COLOR 2 SIDE WEATHERSHIELD
WSJT2

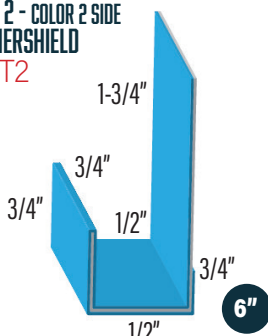

J TRIM 2 - COLOR 2 SIDE DURACLAD/ALLCLAD/DIAMOND
DCJT2

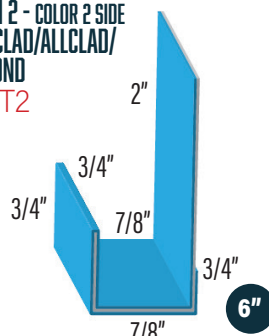

J TRIM 2 - COLOR 2 SIDE WF-7/8" CORRUGATED
CORJT2

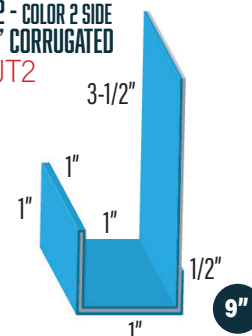

J TRIM 2 - COLOR 2 SIDE PROLOK
PRJT2

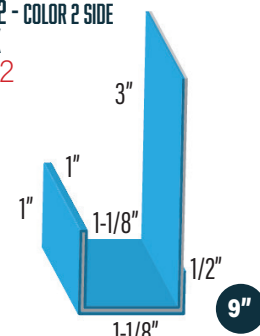

J TRIM 2 - COLOR 2 SIDE WF-12-36
1236JT2

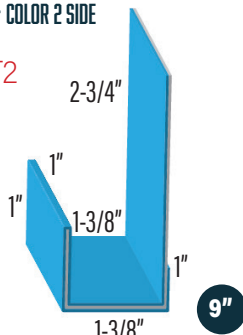

J TRIM 2 - COLOR 2 SIDE WF-636
636JT2

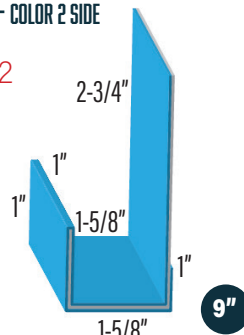

J TRIM VENTED
JTV

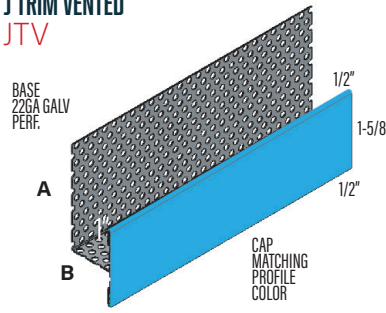

	A	B
PBJTV	2-3/4	3/4
DCJTV	2-5/8	7/8
HFJTV	2-3/8	1-1/8
636JTV	2-7/8	1-5/8

WIDTH	GALV / LUME 29 GAUGE	SMP 29 GAUGE	GALV / LUME 26 GAUGE	SMP 26 GAUGE	PVDF/TEX 26 GAUGE	GALV / LUME 24 GAUGE	SMP 24 GAUGE	PVDF/TEX 24 GAUGE	ALUMINUM 24 GAUGE
4"									
6"									
9"									
12"									
15"									
18"									
24"									
30"									
JTV									

EZLOK TRIM FLASHINGS 2 PC TRIMS

EZLOK TRIMS CONSIST OF BASES AND TOP CAPS

EZLOK J

PROFILE	CODE	DEPTH
WEATHERSHIELD	WSEZJ	1/2"
PROBOARD	PBEZJ	5/8"
DURACLAD/AC/DIA	DCEZJ	7/8"
7/8" CORRUGATED HF/PROLOK	EZJ1	1"
WF-12-36	1236EZJ	1-1/4"
WF-636	636EZJ	1-1/2"



EZLOK T

PROFILE	CODE	DEPTH
WEATHERSHIELD	WSEZT	1/2"
PROBOARD	PBEZT	5/8"
DURACLAD/AC/DIA	DCEZT	7/8"
7/8" CORRUGATED HF/PROLOK	EZT1	1"
WF-12-36	1236EZT	1-1/4"
WF-636	636EZT	1-1/2"

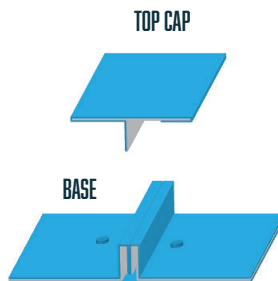

PROBOARD EZLOK O/S CORNER PBEZOC

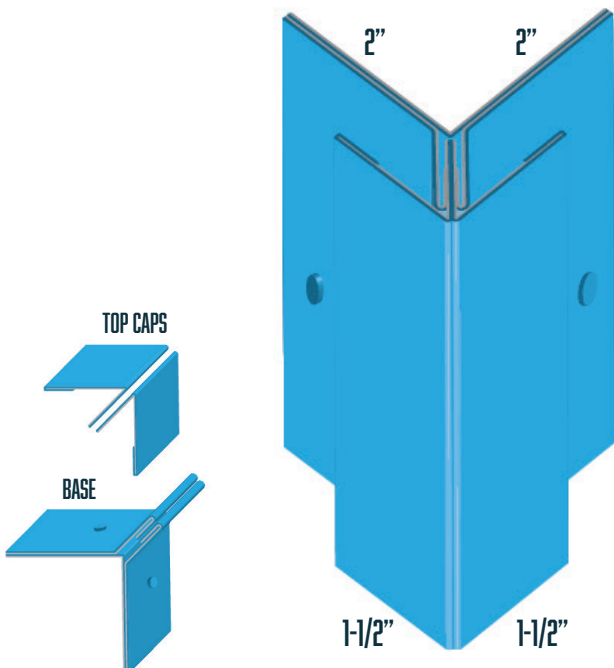

PROBOARD EZLOK I/S CORNER PBEZIC

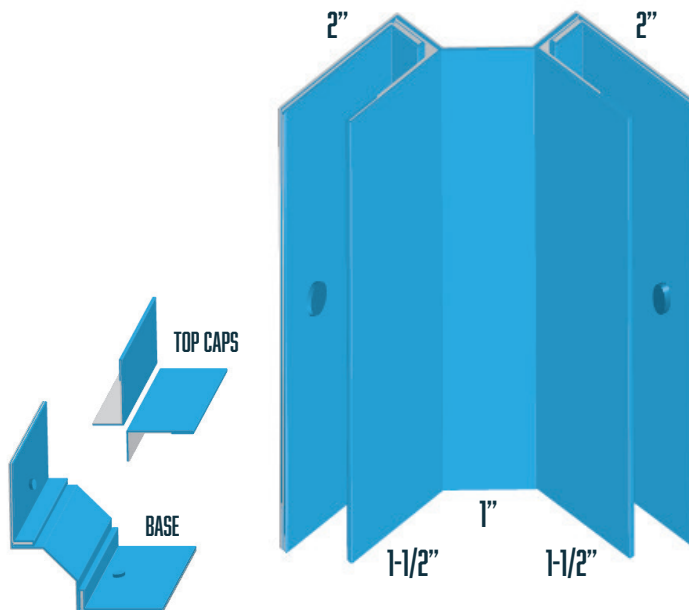

TRIMS SMP 24 GAUGE PVDF/PRINTECH 24 GAUGE

EZLOK J

EZLOK T

PB EZLOK CORNERS

TERMS NET 30 DAYS. PRICES SUBJECT TO CHANGE WITHOUT NOTICE.

WALL TRANSITIONS AND STARTER BOX FLASHINGS

WALL TRANSITION MESA
WMWT

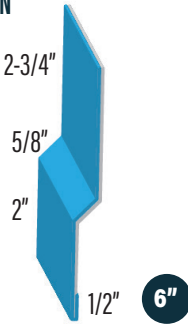

WALL TRANSITION WEATHERSHIELD
WSWT

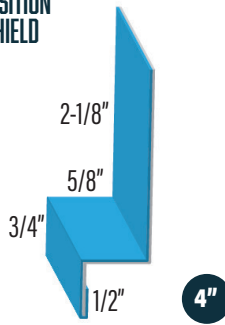

WALL TRANSITION PROBOARD
PBWT

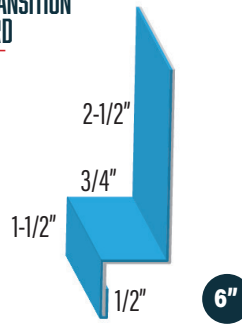

WALL TRANSITION DURACLAD/ALLCLAD/DIAMOND
DCWT

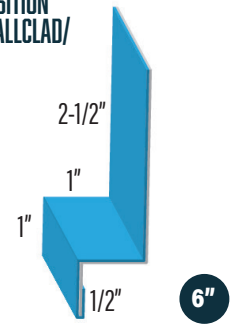

WALL TRANSITION WF-7/8" CORRUGATED
CORWT

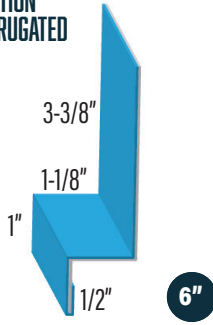

WALL TRANSITION WF-HF/PROLOK
HFWT

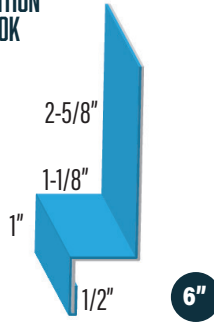

WALL TRANSITION WF-12-36
1236WT

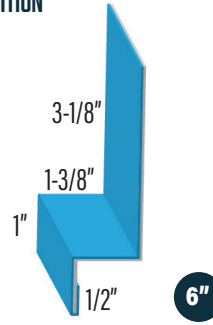

WALL TRANSITION WF-636
636WT

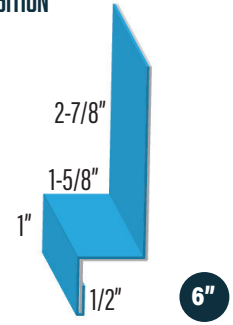

STARTER BOX WEATHERSHIELD
WSSB

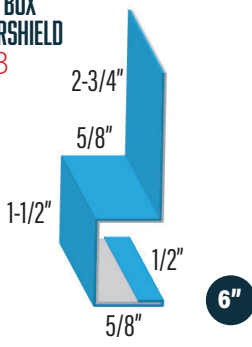

STARTER BOX DURACLAD/ALLCLAD/DIAMOND
SB1

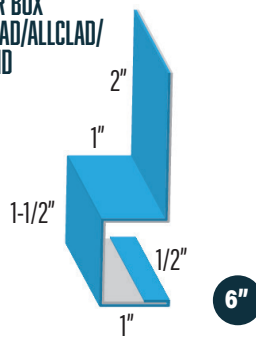

STARTER BOX WF-7/8" CORRUGATED
CORSB

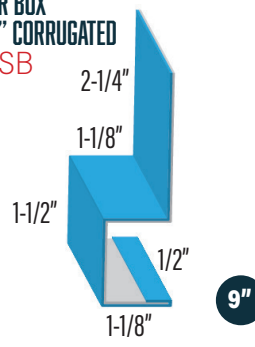

STARTER BOX WF-HF/PROLOK
HFSB

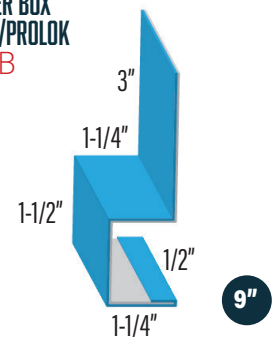

STARTER BOX WF-12-36
1236SB

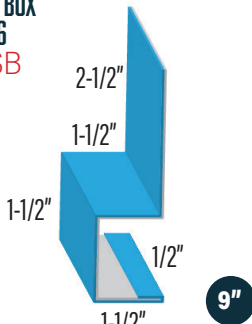

STARTER BOX WF-636
636SB

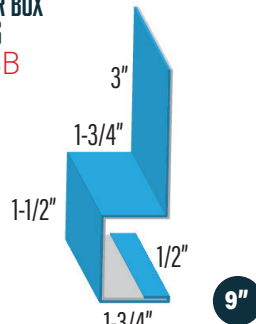

L TRIM



A	B	Code
1/2	2-1/2	PBLT
3/4	2-1/2	DCLT
1	2-1/2	CORLT
1-1/4	2-1/2	1236LT
1-1/2	2-1/2	636LT

WIDTH	GALV / LUME 29 GAUGE	SMP 29 GAUGE	GALV / LUME 26 GAUGE	SMP 26 GAUGE	PVDF/TEX 26 GAUGE	GALV / LUME 24 GAUGE	SMP 24 GAUGE	PVDF/TEX 24 GAUGE	ALUMINUM 24 GAUGE
4"									
6"									
9"									
12"									
15"									
18"									
24"									
30"									
36"									

OUTSIDE CORNER FLASHINGS

**WEATHERSHIELD
WSCC**

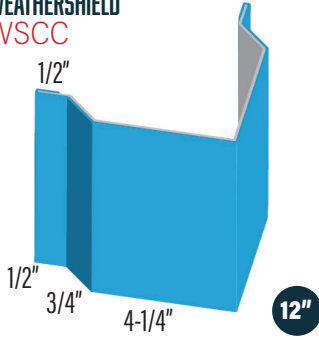

**DURACLAD/ALLCLAD/DIAMOND
DCCC**

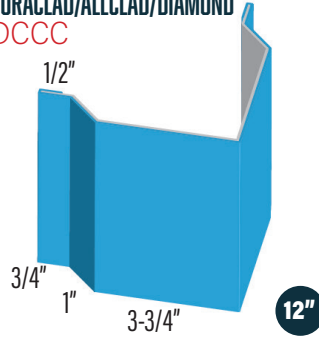

**WF-12-36
1236CC**

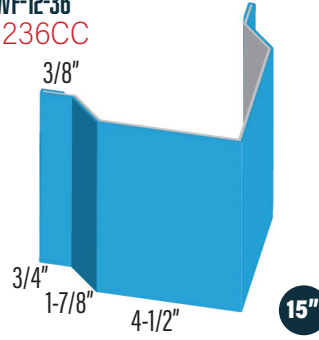

**WF-7/8" CORRUGATED
CORCC**

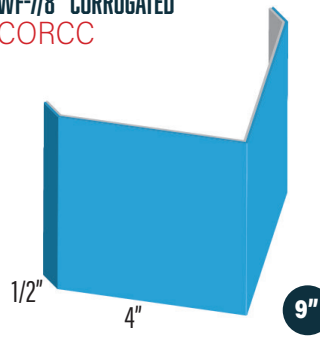

**WF-636 & WF-7/8" CORRUGATED
CORCCH**

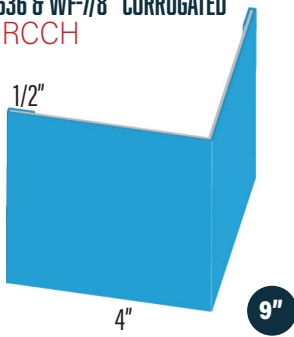

**CORNER POST 1
CP1**

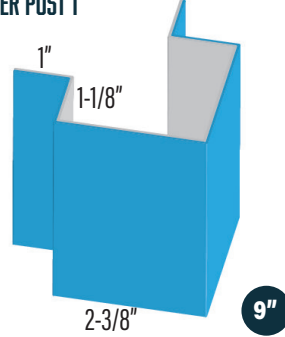

**CORNER POST 2
CP2**

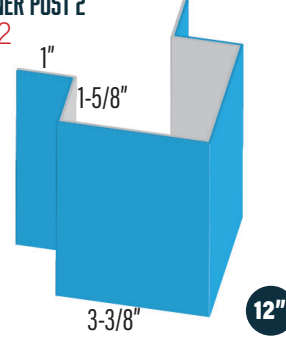

**WEATHERSHIELD
WSOCP**

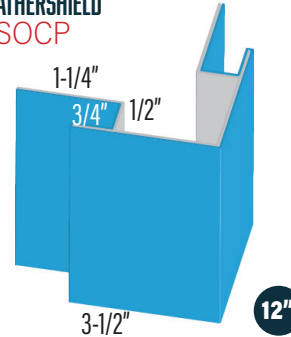

**PROBOARD
PBOCP**

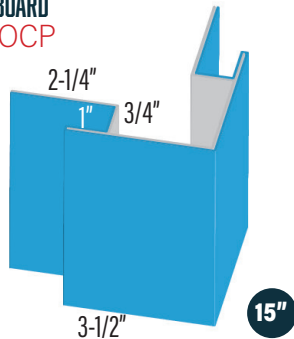

**DURACLAD/ALLCLAD/DIAMOND
DCOCP**

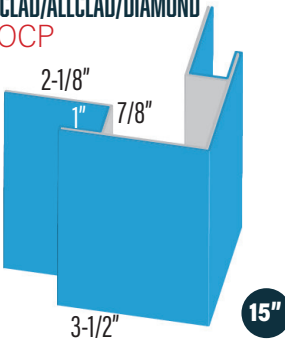

**WF-7/8" CORRUGATED
COROCP**

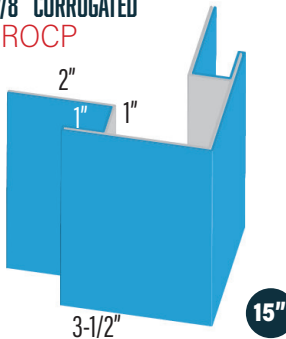

**WF-HF/PROLOK
HFOCP**

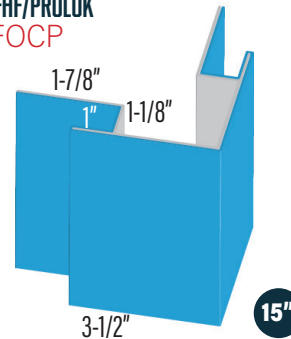

**WF-12-36
1236OCP**

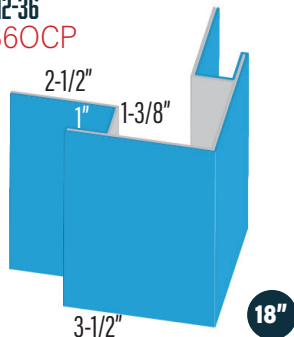

**WF-636
636OCP**

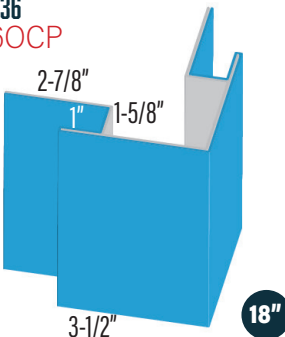

**MESA
WMOCHF**

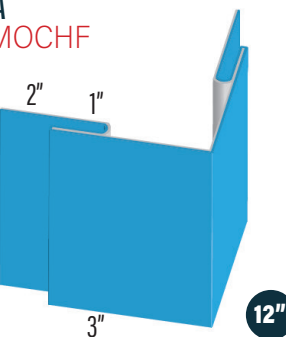

**MESA
WMOC**

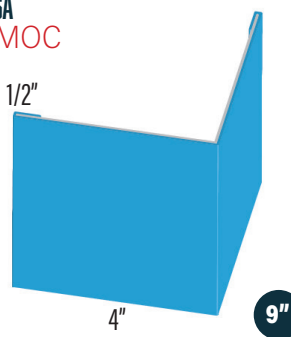

WIDTH	GALV / LUME 29 GAUGE	SMP 29 GAUGE	GALV / LUME 26 GAUGE	SMP 26 GAUGE	PVDF/TEX 26 GAUGE	GALV / LUME 24 GAUGE	SMP 24 GAUGE	PVDF/TEX 24 GAUGE	ALUMINUM 24 GAUGE
4"									
6"									
9"									
12"									
15"									
18"									
24"									
30"									
36"									

INSIDE CORNER FLASHINGS

WEATHERSHIELD
WSICC

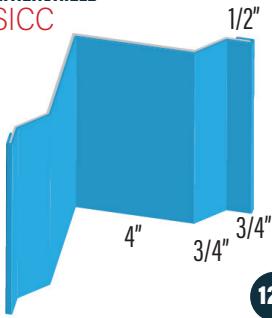

DURACLAD/ALLCLAD/DIAMOND
DCICC

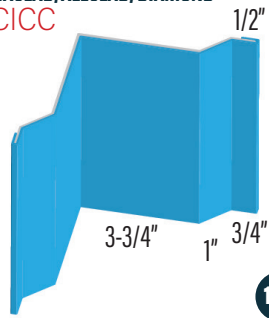

WF-12-36
1236ICC

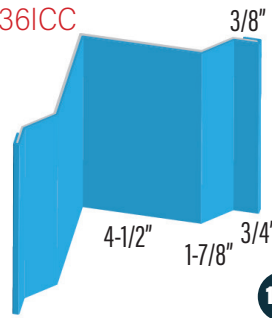

WF-7/8" CORRUGATED
CORICC

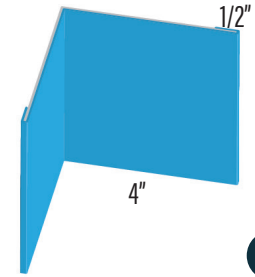

MESA
WMIC



INSIDE CORNER POST 1
ICP1

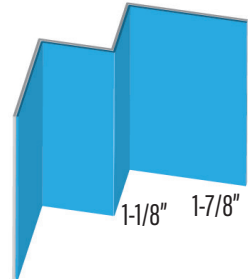

INSIDE CORNER POST 2
ICP2

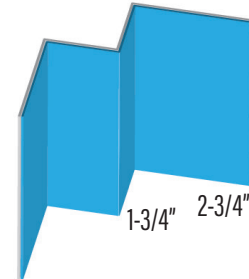

WEATHERSHIELD
WSICP

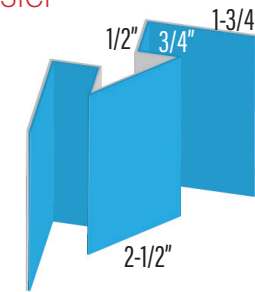

PROBOARD
PBICP

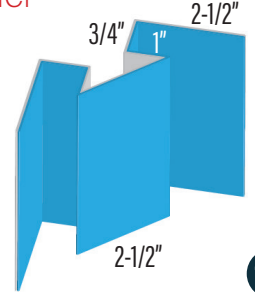

DURACLAD/ALLCLAD/DIAMOND
DCICP

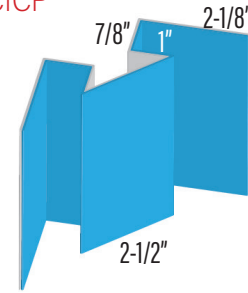

WF-7/8" CORRUGATED
CORICP

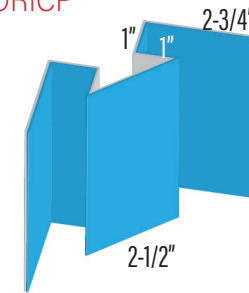

WF-HF/PROLOK
HFICP

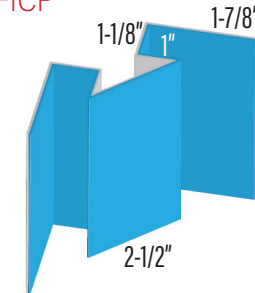

WF-12-36
1236ICP

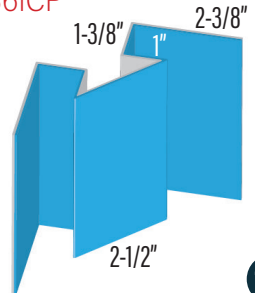

WF-636
636ICP

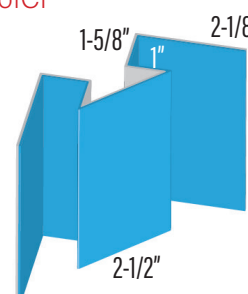

INSIDE CORNER TRIM 1
ICT1

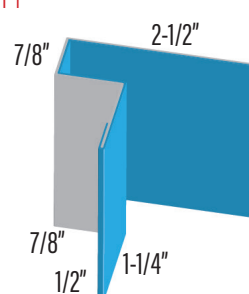

INSIDE CORNER TRIM 2
ICT2

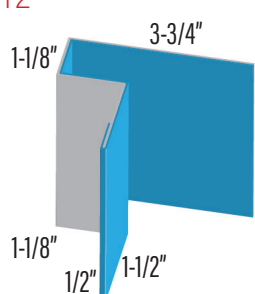

MESA
WMICHF

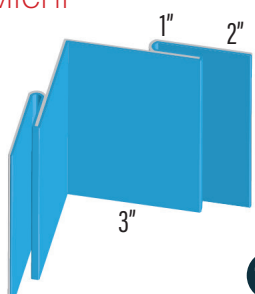

WIDTH	GALV / LUME 29 GAUGE	SMP 29 GAUGE	GALV / LUME 26 GAUGE	SMP 26 GAUGE	PVDF/TEX 26 GAUGE	GALV / LUME 24 GAUGE	SMP 24 GAUGE	PVDF/TEX 24 GAUGE	ALUMINUM 24 GAUGE
4"									
6"									
9"									
12"									
15"									
18"									
24"									
30"									
36"									

QUICK LOCK CORNER FLASHINGS

OUTSIDE CORNER
 QLOC.75
 QLOC1

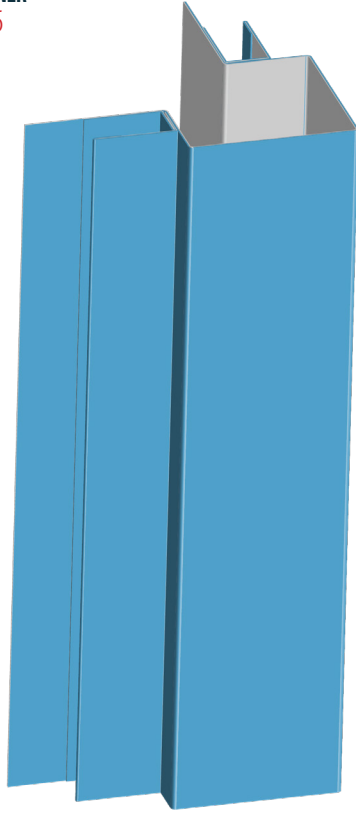

INSIDE CORNER
 QLIC.75
 QLIC1

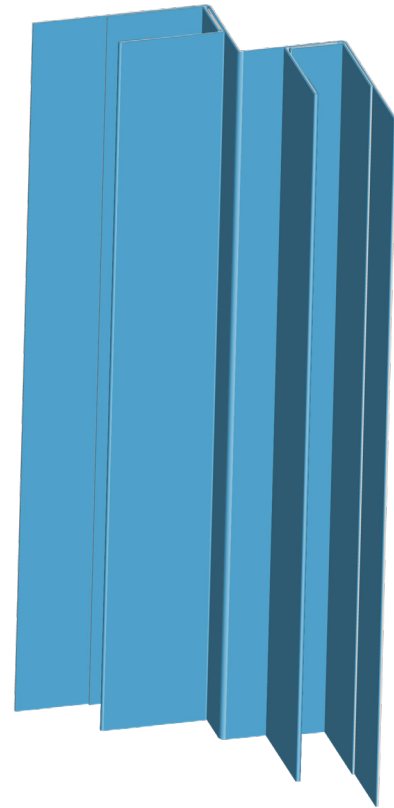

QLOC.75 for 3/4" profiles
 QLOC1 for 1" profiles

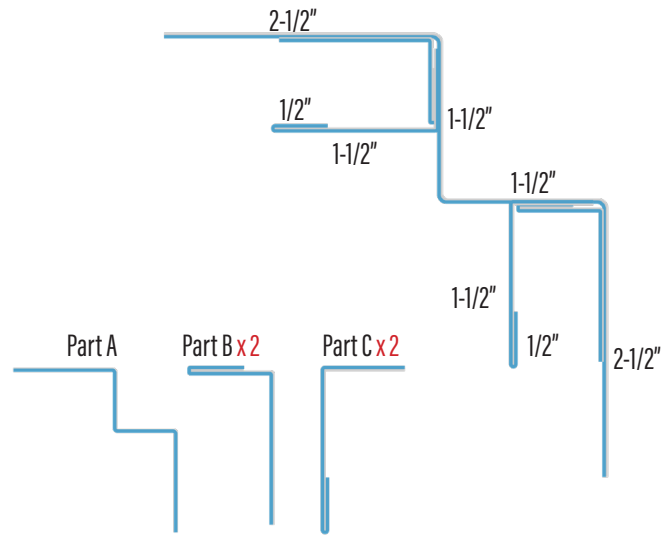
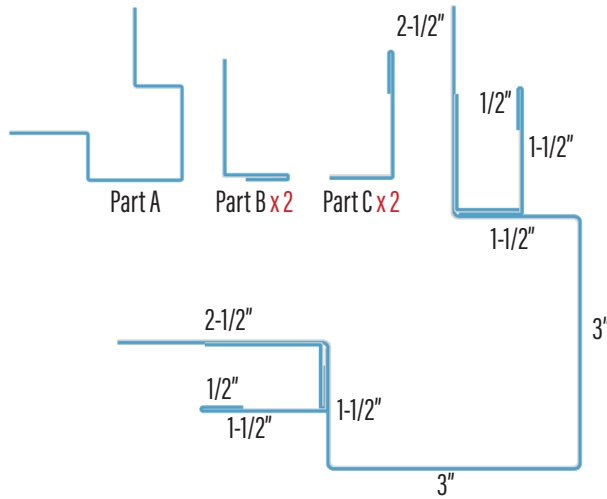

WIDTH	GALV / LUME 29 GAUGE	SMP 29 GAUGE	GALV / LUME 26 GAUGE	SMP 26 GAUGE	PVDF/TEX 26 GAUGE	GALV / LUME 24 GAUGE	SMP 24 GAUGE	PVDF/TEX 24 GAUGE	ALUMINUM 24 GAUGE
4"									
6"									
9"									
12"									
15"									
18"									
24"									
QLIC									
QLOC									

TERMS NET 30 DAYS. PRICES SUBJECT TO CHANGE WITHOUT NOTICE.

MISC. FLASHINGS

DIVIDER 1
7/8" CORRUGATED/WF-HF
DIV1

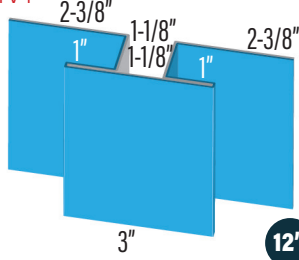

DIVIDER 2
7/8" CORRUGATED/WF-HF
DIV2

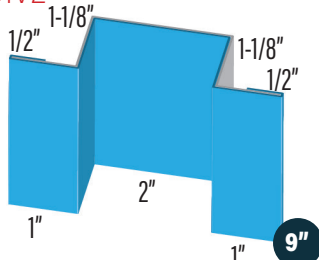

DOUBLE STARTER MESA
WMDS

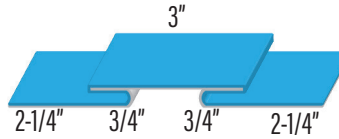

DIVIDER
PROBOARD
PBD

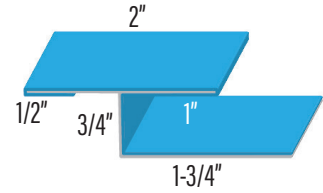

BATTEN TRIM
PROBOARD
PBBT

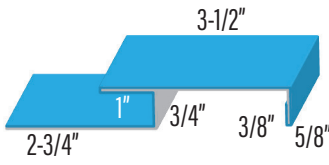

SOFFIT DRIP
WF-HF
SODC

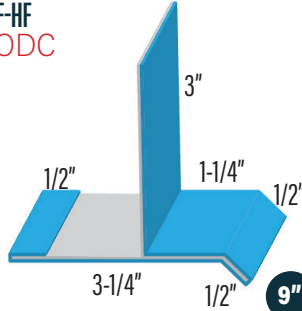

EAVE MESA
WMEAVE

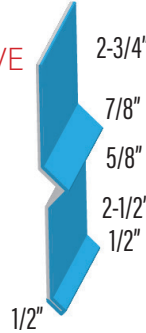

WINDOW DRIP MESA
WMWDC

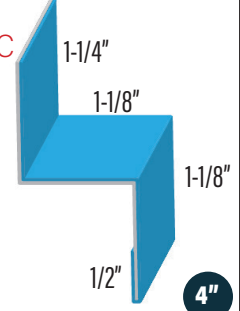

SKIRT MESA
WM1RIB

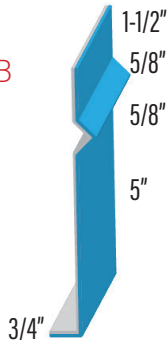

SKIRT MESA
WM2RIB

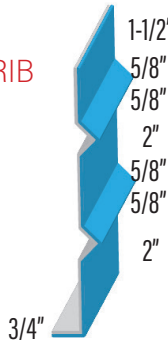

BASE TO CONCRETE
BTC

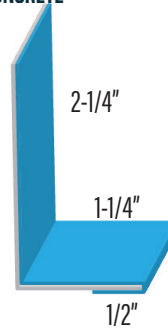

SOFFIT TO WALL
WF-HF
SOTW

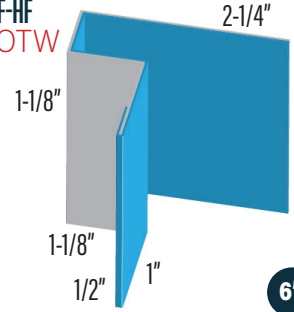

PANEL SUPPORT
PROBOARD
PBZBAR

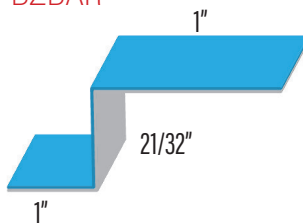

PANEL SUPPORT
WF-HF
HFZBAR

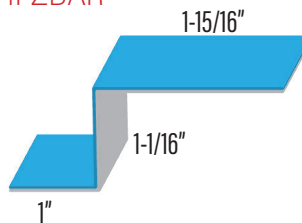

Z BAR TRIM SUPPORT (226A)
PROLOK
PROZBAR

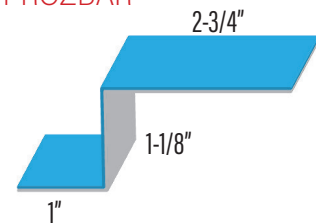

WIDTH	GALV / LUME 29 GAUGE	SMP 29 GAUGE	GALV / LUME 26 GAUGE	SMP 26 GAUGE	PVDF/TEX 26 GAUGE	GALV / LUME 24 GAUGE	SMP 24 GAUGE	PVDF/TEX 24 GAUGE	ALUMINUM 24 GAUGE
4"									
6"									
9"									
12"									
15"									
18"									
24"									
30"									
36"									

PANEL SUPPORT - EACH RIDGE/HIP SUPPORT (226A) - EACH

TERMS NET 30 DAYS. PRICES SUBJECT TO CHANGE WITHOUT NOTICE.

CHIMNEY FLASHINGS

ROOF FLASHINGS WILL BE 4/12 PITCH UNLESS OTHERWISE SPECIFIED

CHIMNEY SIDEWALL WEATHERSHIELD
WSCHSW

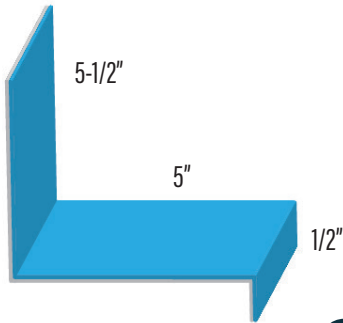

CHIMNEY SIDEWALL DURACLAD/ALLCLAD/DIAMOND
DCCHSW

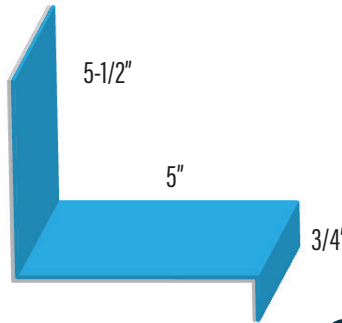

CHIMNEY SIDEWALL WF-7/8" CORRUGATED
CORCHSW

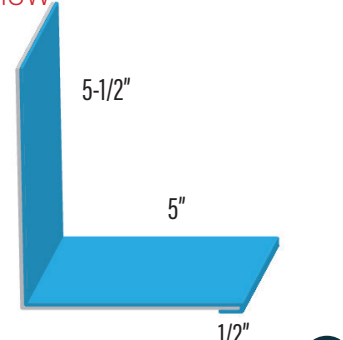

CHIMNEY SIDEWALL PROLOK
PRCHSW

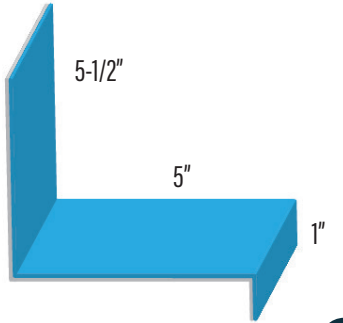

CHIMNEY SIDEWALL WF-12-36
1236CHSW

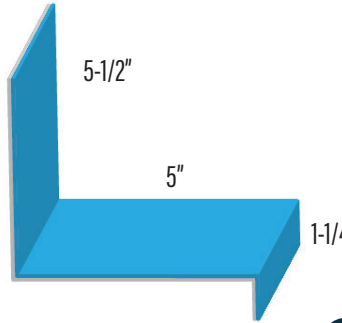

CHIMNEY SIDEWALL WF-636
636CHSW

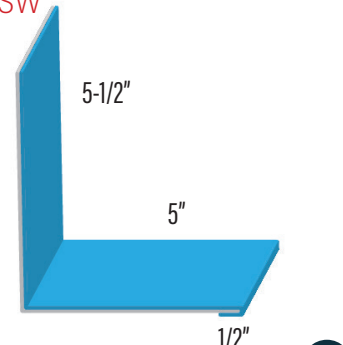

CHIMNEY PAN
CHPAN

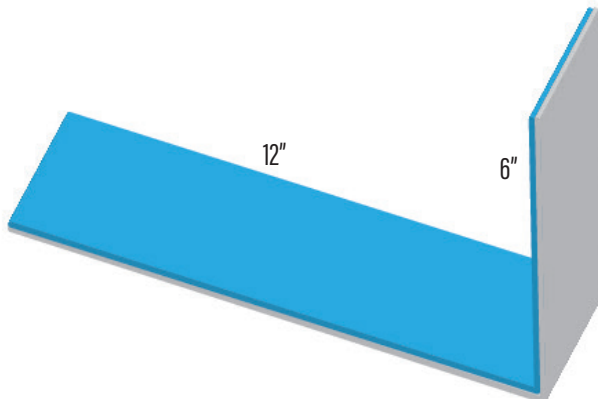

SPECIFY PITCH

CHIMNEY END WALL
CHEW

SPECIFY PITCH

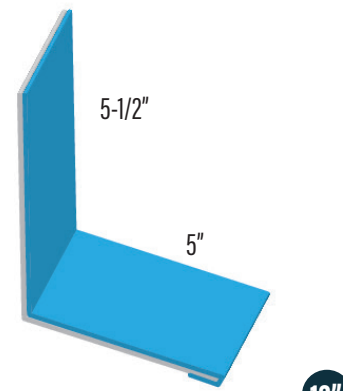

WIDTH	GALV / LUME 29 GAUGE	SMP 29 GAUGE	GALV / LUME 26 GAUGE	SMP 26 GAUGE	PVDF/TEX 26 GAUGE	GALV / LUME 24 GAUGE	SMP 24 GAUGE	PVDF/TEX 24 GAUGE	ALUMINUM 24 GAUGE
4"									
6"									
9"									
12"									
15"									
18"									
24"									
30"									
36"									

TERMS NET 30 DAYS. PRICES SUBJECT TO CHANGE WITHOUT NOTICE.

SKYLITE FLASHINGS

SKYLITE PAN 1A
A = 2X4 CURB HEIGHT
SKY1A

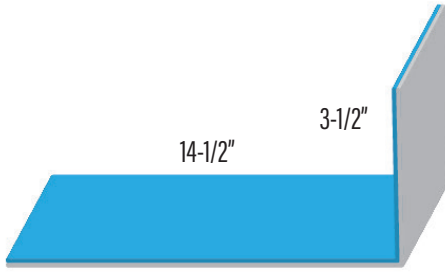

18"

SKYLITE PAN 1B
B = 2X6 CURB HEIGHT
SKY1B

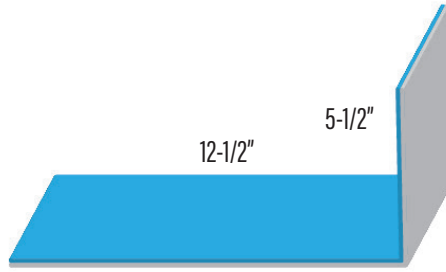

18"

SKYLITE PAN 1C
C = 2X8 CURB HEIGHT
SKY1C

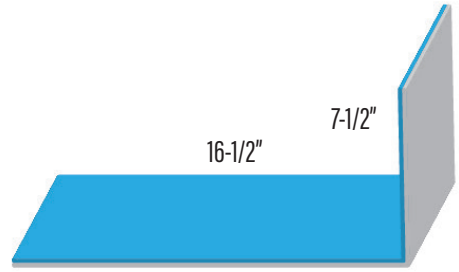

24"

SKYLITE 2-A, B, C
WEATHERSHIELD
WSSKY2-A,B,C

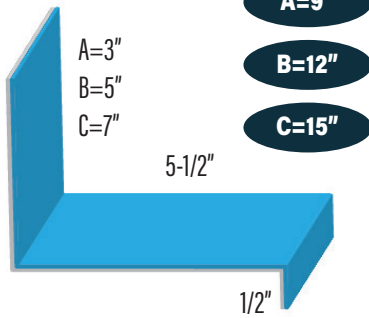

- A=9"
- B=12"
- C=15"

SKYLITE 2-A, B, C
DURACLAD/ALLCLAD/DIAMOND
DCSKY2-A,B,C

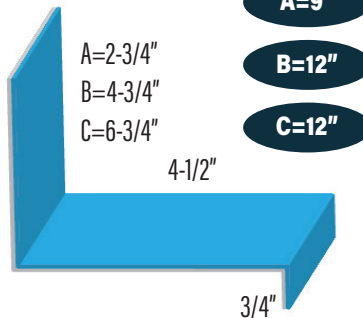

- A=9"
- B=12"
- C=12"

SKYLITE 2-A, B, C
WF-7/8" CORRUGATED
CORSKY2-A,B,C

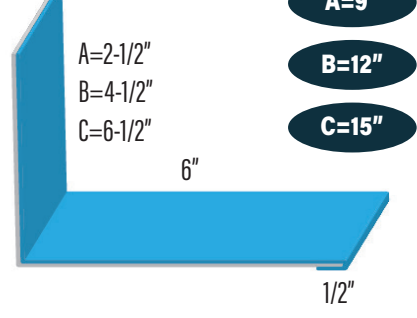

- A=9"
- B=12"
- C=15"

SKYLITE 2-A, B, C
PROLOK
PRSKY2-A,B,C

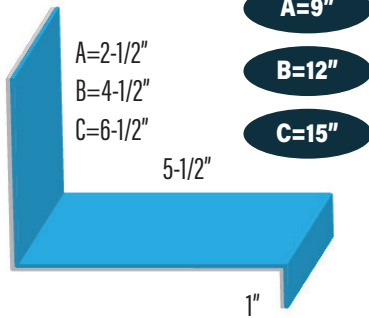

- A=9"
- B=12"
- C=15"

SKYLITE 2-A, B, C
WF-12-36
1236SKY2-A,B,C

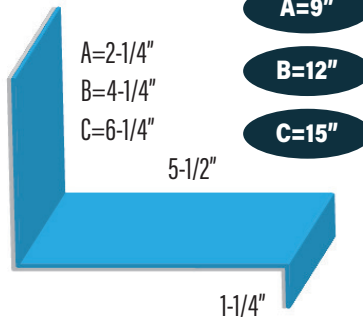

- A=9"
- B=12"
- C=15"

SKYLITE 2-A, B, C
WF-636
636SKY2-A,B,C

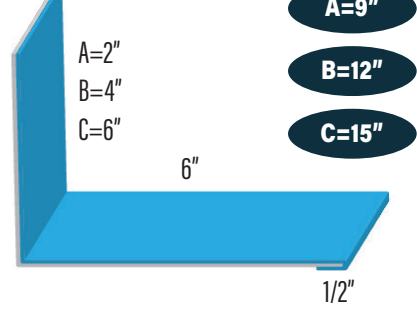

- A=9"
- B=12"
- C=15"

WIDTH	GALV / LUME 29 GAUGE	SMP 29 GAUGE	GALV / LUME 26 GAUGE	SMP 26 GAUGE	PVDF/TEX 26 GAUGE	GALV / LUME 24 GAUGE	SMP 24 GAUGE	PVDF/TEX 24 GAUGE	ALUMINUM 24 GAUGE
4"									
6"									
9"									
12"									
15"									
18"									
24"									
30"									
36"									